

USER MANUAL

DM0636

Multi-purpose Centrifuge



Before using centrifuge, please carefully read this user manual for its efficient operation and safety.

Contents

| | |
|--|----|
| Copyright: | 0 |
| Safety Reminder | 1 |
| 1. Specifications | 3 |
| 2. Declaration of Conformity | 3 |
| 3. Required Operational Condition | 4 |
| 3.1 Basic operational Conditions..... | 4 |
| 3.2 Transport and storage condition | 4 |
| 4. Installation..... | 4 |
| 4.1 Location..... | 5 |
| 4.2 Connection of the power cord and grounding | 5 |
| 5. Structure | 5 |
| 6. Operation panel | 6 |
| 7. Rotor Preparation | 7 |
| 7.1 Prepare the samples | 7 |
| 7.2 Inject the samples into tubes. | 7 |
| 7.3 Keep the tubes balance | 7 |
| 7.4 Inspect the rotor..... | 8 |
| 7.5 Symmetrically load centrifuge tubes in rotor | 8 |
| 8. Operation..... | 8 |
| 8.1 Normal Operation..... | 8 |
| 8.2 RCF Operation | 12 |
| 8.3 Pulse Operation | 12 |
| 9. Maintenance | 12 |
| 9.1 Cleaning | 12 |
| 9.2 Consumables | 13 |
| 9.3 The replacement of seal rings..... | 13 |
| 9.4 Routine inspection..... | 14 |
| 10. Troubleshooting..... | 14 |
| 10.1 Possible problems and solutions..... | 14 |
| 10.2 How to open the door | 15 |
| 10.3 Replacement of fuses..... | 16 |
| 11. Instructions of rotor and tube | 16 |
| 11.1 The rotor instructions..... | 16 |
| 11.2 Tubes | 18 |
| 12. Calculate Relative Centrifuge Force(RCF) | 19 |
| 13. Ordering information..... | 20 |
| 14. Warranty | 21 |
| 14.1 Warranty of the centrifuge..... | 21 |
| 14.2 Warranty of the rotor | 21 |
| 15. After-sales Service..... | 21 |

Copyright:

No part of this manual may be reproduced or transmitted without prior written permission of original manufacture.

We can not be responsible to inform at real-time if the outline and specifications of centrifuge is subject to change for improvement.

VERSION201510

Safety Reminder

Common safety precautions

Carefully read the following safety precautions for a thorough understanding.

- Follow the instructions and procedures described in this manual to operate this centrifuge safely.
- Carefully read all safety messages in this manual and the safety instructions on the instrument.
- Safety messages are labeled as indicated below. They are in combination with signal words of “WARNING” and “CAUTION” with the safety alert symbol  to call your attention to items or operations that could be dangerous to you or other persons using this instrument. The definitions of signal words are as follows:

 **WARNING:** Personal Danger

Warning notes indicate any condition or practice, which if not strictly observed, could result in personal injury or possible death.

 **CAUTION:** Possible damage to instrument

Caution notes indicate any condition or practice, which if not strictly observed or remedied, could result in damage or destruction of the instrument.

NOTE: Notes indicate an area or subject of special merit, emphasizing either the product’s capability or common errors in operation or maintenance.

- Do not operate this centrifuge in any manner not described in this User manual. When in doubt or have any troubles with this centrifuge, ASK FOR HELP.
- The precautions described in this User manual are carefully developed in an attempt to cover all the possible risks. However, it is also important that you are alert for unexpected incidents. Be carefully operating this centrifuge.



WARNING:

- This centrifuge is not explosion-proof. Never use explosive or flammable samples.
- Do not install the centrifuge in or near places where inflammable gases are generated or chemicals are stored.
- Do not place dangerous material within 30cm around the centrifuge.

- Make sure to prepare necessary safety measures before using samples that are toxic, radioactive or contaminated with pathogenic micro-organisms at your own responsibility.
- If the instrument, rotor and/or accessories that has been contaminated by solutions with toxic, radioactive or pathogenic materials, clean it according to the decontamination procedure that you are specified.
- If you require services at site, please sterilize and decontaminate it in advance, and then notice the service center involved in the details of the particular materials.
- Do not handle the power cord or turn on or off the POWER switch with wet hands to void electrical shocks.
- For safety purposes, do not enter within 30cm around this centrifuge while it is in operation.
- While the rotor is rotating, never forcedly release the door lock.
- Unauthorized repairs, disassembly, and other services to the centrifuge except by our service center are strictly prohibited.



CAUTION

- This centrifuge must be located on one firm and level table.
- Make sure the centrifuge is horizontal before running.
- Make sure the angle between the door and cover is greater than 70 degrees when open the door.
- Be careful not put your fingers or hands between the door and cover when the door off.
- Do not move or relocate this centrifuge while it is running.
- If fluid spills in the rotor chamber, please promptly clean and dry with a dry cloth to avoid sample contamination.
- Ensure to remove any objects and fragments of the tubes dropped inside the rotor chamber before running this centrifuge.
- Cautions on rotors
 - (1) Always check for corrosion and damages on the rotor surface before using it. Do not use the rotor if an abnormality is found.
 - (2) Do not set the centrifuge speed beyond the allowable minimum speed of the rotor kits (rotor or adapters). Make sure to run it below the allowable minimum speed.
 - (3) Do not exceed the allowable imbalance.
 - (4) Use the rotor and tubes within their actual capacities.
 - (5) If the rotor is attached with a lid, ensure it is tightened before operation.
- If any abnormal condition occurs during operation, please stop it immediately and contact our service center. Notify the service center is a warning code if displayed.
- Vibrations are likely to damage the centrifuge, contact our service center if abnormality observed.

1. Specifications

| | |
|-----------------------------|--|
| Maximum speed | 6000rpm(300-6000rpm), increment: 10rpm |
| Speed accuracy | ±20rpm |
| Maximum RCF | 4020×g, increment: 10×g |
| Maximum capacity | 100ml×4(swing out rotor), 50ml×6 (angle fix rotor) |
| Rotor types | Swing out rotor: 100ml×4, micro plate rotor |
| | Angle rotor: 2.0ml×30, 2.0ml×60, 5.0mlV×18, 50mlV×6, pcr8×12, 15ml×30, 50ml×8, |
| Timer | 30seconds -99minutes-HOLD, continuous operation |
| Driving Motor | Brushless DC motor |
| Memory | 9 |
| Acceleration / Deceleration | 9 ↑ /10 ↓ (deceleration10: free braking) |
| Safety devices | Dual door interlock、Over-speed detector、Chamber over-temperature detector、Motor over-temperature detector、Imbalance protection, Automatic internal diagnosis |
| Power requirements | Single-phase, 220V-240V, 50Hz/60Hz, 8A. 110V-120V, 50Hz/60Hz, 12A |
| Dimensions (mm) | (L) 280× (W) 364× (H) 266 |
| Weight | 30kg |
| Additional features | Speed/RCF switch、Pulse operation、Processing display、Voice reminder |

2. Declaration of Conformity

| |
|--|
| Construction in accordance with the following safety standards: |
| EN 61010-1 |
| EN 61010-2-020 |
| Construction in accordance with the following EMC standards: |
| EN 61326-1/ FCC Part 15 Subpart B/ IECS 001 |
| Associated EU guidelines: |
| EMC-guidelines: 2004/108/EC |
| Instrument guidelines: 2006/95/EC |
| This ISM device complies with Canadian ICES-001. |

Changes or modifications not expressly approved by the party responsible for compliance could void the user's authority to operate the equipment.

NOTE: This centrifuge has been tested and found to comply with the limits for a Class A digital device, pursuant to Part 15 of the FCC Rules. These limits are designed to provide reasonable protection against harmful interference when the centrifuge is operated in a commercial environment. The centrifuge generates, uses, and can radiate radio frequency energy and, if not installed and used in accordance with the user manual, may cause harmful interference to radio communications. Operation of centrifuge in a residential area is likely to cause harmful interference in which case the user will be required to correct the interference.

3. Required Operational Condition

3.1 Basic operational Conditions

- (1) Power:
 - Single-phase, 220V-240V, 50Hz/60Hz, 8A;
 - Single-phase, 110V-120V, 50Hz/60Hz, 12A;
- (2) Ambient temperature: 2°C ~ 40°C.
- (3) Relative humidity: ≤ 80%.
- (4) No vibration and airflow around.
- (5) No electric dust, explosive and corrosive gases around.

3.2 Transport and storage condition

- (1) Storage temperature: -40°C ~ 55°C.
- (2) Relative humidity: ≤ 93%.

4. Installation

This section describes the instructions that you should abide when install the centrifuge to ensure your safety and the optimum performance. Before moving the centrifuge, the rotor must be removed.



WARNING:

- Improper power supply may damage centrifuge.
- Make sure the power source conforms to the required power supply before connecting.

4.1 Location

(1) Place the centrifuge on a firm, flat and level table, ensure the four feet of this centrifuge stand on the table firmly. Avoid installing on the slippery surface or surface prone to vibration.

(2) Ideal ambient temperature is $20^{\circ}\text{C} \pm 5^{\circ}\text{C}$, avoid placing the centrifuge in direct sunlight if temperature exceeds 30°C .

(3) Keep clear of the centrifuge at least 10cm on both sides and at least 30cm behind it to guarantee the cooling efficiency.

(4) Keep away from heat or water to avoid sample temperature issues or centrifuge failures.

4.2 Connection of the power cord and grounding

⚠ WARNING:

- To avoid electrical shocks, ensure your hands are dry when touching the power cord.
- This centrifuge must be grounded properly.

A minimum 10A outlet providing a sufficient ground is required, and this must meet with local safety requirements.

5. Structure

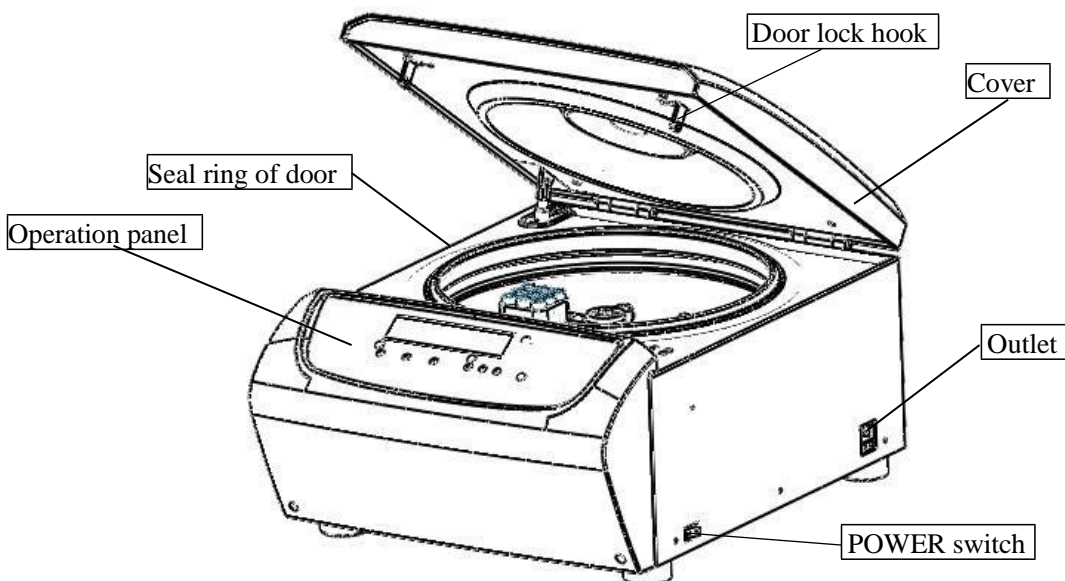

Figure 5.1 D1536 Front view of the centrifuge

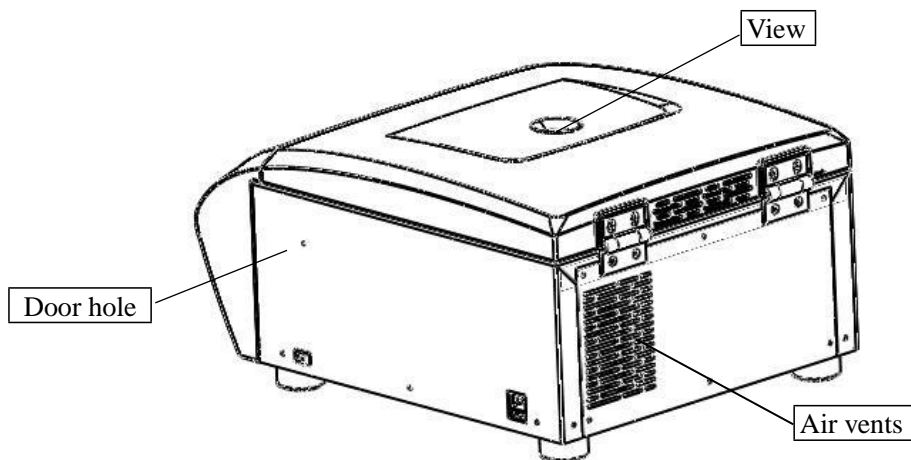

Figure 5.2 D1536 back view of the centrifuge

6. Operation panel

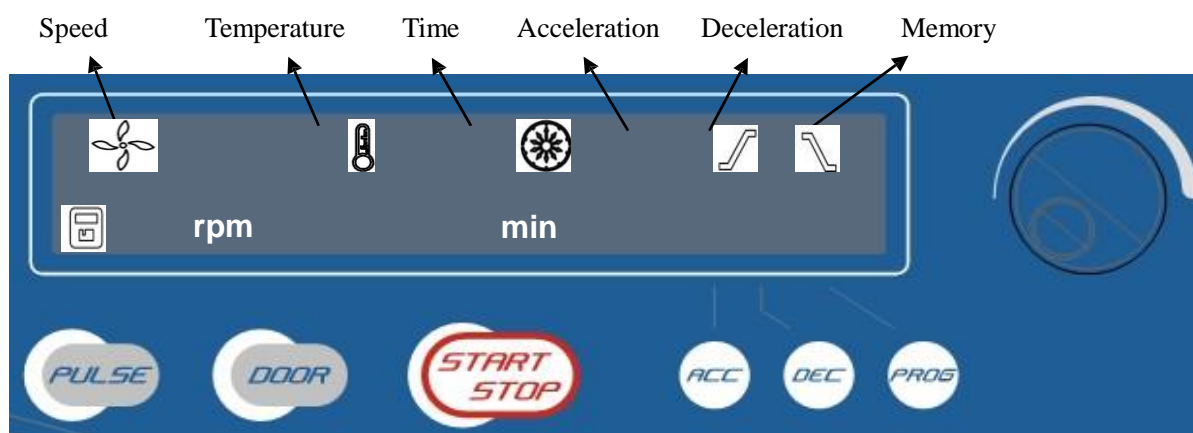





Figure 6-1 Operation Panel

| Item | Symbol | Name | Function |
|------|---|------------------|---|
| 1 |  | Pulse key | When the door closed, press and hold the key to accelerate running, release the key to stop it. |
| 2 |  | Open/ lock key | Press the key to open the door The key is not available when the centrifuge is running. |
| 3 |  | Start/ Stop key | Press the key to start running. The centrifuge will brake to stop running if press the key during centrifugation. |
| 4 |  | Acceleration key | Press the key to set the acceleration curve. 1: the slowest acceleration. 9: the fastest acceleration |





| | | | |
|---|---|------------------|--|
| 5 |  | Deceleration key | Press the key to set the deceleration curve. 0: inertial braking. 9: fastest braking. |
| 6 |  | Memory key | Load program: Press the key shortly to load the program Save program: Press and hold key for 5 seconds |
| 7 |  | Parameter key | Clockwise rotate to increase parameter values. counter-clockwise rotate to decrease parameter values. Press down the key, shift between speed , RCF and time display. |



Figure 6-2 the main interface

Main interface is as figure 6-2. The speed is set to be 6000rpm, temperature of centrifugal chamber is 20°C, and the running time is 30 minutes, acceleration curve is 9, and deceleration curve is 9, memory program is 7. When speed symbol  is rotating, indicating the centrifuge is running, the rotation is faster, the speed is higher. Temperature only displays the temperature of chamber and can not be controlled. Time symbol  displays the ratio of working to time setting. The total time setting is divided into 10 scales.

7. Rotor Preparation

7.1 Prepare the samples

7.2 Inject the samples into tubes.

| |
|--|
| <p> CAUTION:</p> <ul style="list-style-type: none"> ● Do not overload samples into the centrifuge which will cause leaking. ● Do not exceed the actual capacity allowed in the user manual. |
|--|

7.3 Keep the tubes balance

- Although the centrifuge can accept sample balancing by eye, we recommend that you keep this centrifuge in a well-balanced condition to extend its life expectancy.
- Never intentionally run the centrifuge under unbalanced condition even though the allowable

imbalance is not exceeded.

7.4 Inspect the rotor

Check the rotor for corrosion or scratches before using.

-  CAUTION:
- If any abnormality such as corrosions or scratches are found, stop using the rotor and contact our service center.
 - Only manufacturer's rotors must be used with the unit.

7.5 Symmetrically load centrifuge tubes in rotor

-  CAUTION:
- Make sure the rotor lid is securely fixed on the rotor, as well as the rotor and shaft are tightened. Otherwise, the rotor may be moved off while rotating and cause damage of the centrifuge and rotor.
 - Firmly tighten the rotor door with rotor.

8. Operation

-  CAUTION:
- Do not push or lean against the centrifuge while it is running.
 - Do not run the centrifuge when fragments or sample solutions are left in the centrifuge chamber. Always keep the centrifugal chamber clean.
 - If the centrifuge makes strange noise during operation, stop it immediately and contact our service center. Notify them of the warning code if displayed.

8.1 Normal Operation

Turn on the power switch, centrifuge will start self-diagnostic checks, see figure 8-1 below:

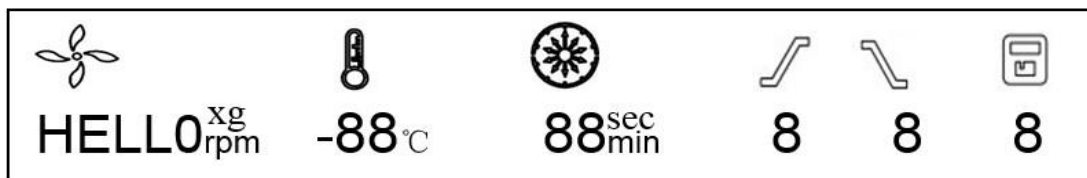

Figure 8-1 Self-checking interface

After self-checking, instrument will display accumulative running time, see figure below:

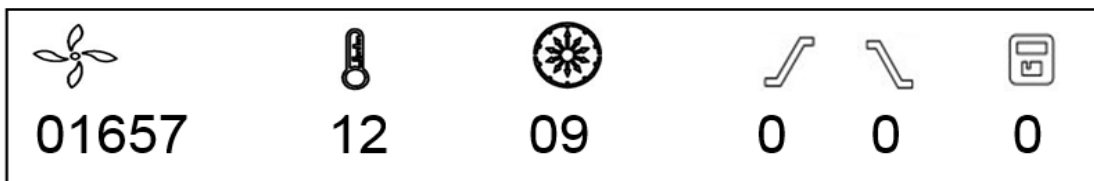

Figure 8-2 Accumulative running time interface

Figure 8-2 indicates the centrifuge has accumulated running time 1657 hours 12 minutes and 9 seconds, and then the centrifuge displays the last running values, see figure 8-3 below:



Figure 8-3 Last running interface

- Speed: 6000rpm. Running time: 30 minutes.
- The door lock is released.

8.1.1 Load and replace the rotor

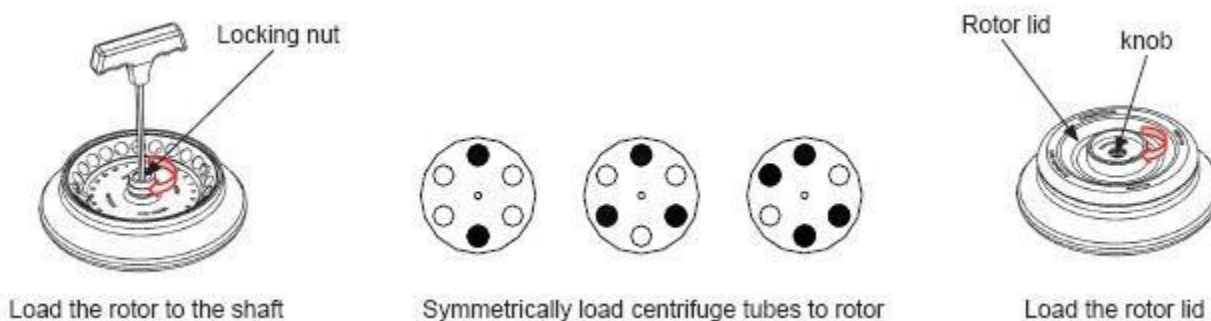

Figure 8-2 Load the rotor

CAUTION





- Attach the rotor to the rotor shaft. Ensure the rotor is in position and connected with the shaft, tightening the locking nut to secure the rotor with shaft, to prevent the rotor damaging the centrifuge.
- Ensure the rotor lid is firmly tightened to the rotor.

- Load the rotor to shaft to ensure rotor is in position until it connected with the shaft.
- You should feel a „click“ when the rotor is properly loaded to the shaft. If not, there may be something







stuck between the rotor and the shaft. Double check and clean it if necessary.

- Rotate the rotor slightly with your fingers to check if the rotor vibrates. If so reinstall the rotor again.
- Rotate the nut clockwise using the wrench to tighten the rotor to the shaft firmly.
- Close the rotor lid, firmly tighten clockwise the lid to the rotor and ensure is in position. Close the door and then start running.
- The method of removing the rotor is as same as the above mentioned by turning the locking nut counterclockwise.



8.1.2 Set the operation parameters

Press the  key to select required parameters. The parameter can be modified when the parameter is flashing. Clockwise rotate the parameter key  to increase parameter value; counter-clockwise rotate the parameter key  to decrease parameter value. Parameter key  rotate faster, parameter value increase faster. The minimum speed increment is 100 rpm, the minimum time increment is 1 second.



(1) Set the speed

- Press the key  until the speed rpm is displayed.
- When the speed is selected, the speed symbol will flash the speed value.
- The minimum speed value you can set 300rpm, the minimum increment is 100rpm.
- Rotate parameter key  clockwise to increase speed value, rotate the parameter key  anti-clockwise to decrease speed value.
- You can speed-up set the speed value by rotating parameter key  quickly.
- There is a circulating function to increase/decrease the speed values. Rotate the parameter key clockwise  to change settings from small → large → maximum → minimum. Rotate the parameter key anti-clockwise  to change settings from large → small → minimum → maximum.



(2) Set the time

- Press key , time value flashes in the time setting mode.
- Rotate the parameter key  to set running time from 10 seconds to 99 minutes.
- When time displays HD, this is a continuous running mode.

(3) Set acceleration and deceleration

- Press key  (ACC), acceleration value flash, press the  (ACC) again, the value will increasing.the value will change from 1 to 9, then from 9 to 1.

1 acceleration: the slowest acceleration; 9 acceleration: the fastest acceleration.

- Press key  (DEC), deceleration value flash, press the  (DEC) again, the value will increasing.the value will change from 0 to 9, then from 9 to 0.

0 deceleration: free braking;

1 deceleration: the slowest deceleration; 9 deceleration: the fastest deceleration.

(4) Set program

There are 1 ~ 9 program groups.

- Saving the program

Press and hold the key  more than 5 seconds, the current parameters are saved under the selected program number.

- Loading the program



Press the key  shortly, the program number will be increasing, from 1 to 9, then from 9 to 1, the corresponding parameters changing as well.

8.1.4 Start the operation

(1) Press key  to start running

- The door should be locked before rotor starts rotating.
- Timer will operate once the speed setting value is reached, the screen displays the remaining run time.

(2) View and modify the operation programs

- Pressing key , returns the display to the program interface and displays settings programs. Press the key  to the desired program. When flashing, rotate the key  to modify values. Release the key after 5 seconds, and the centrifuge will return to normal operation mode and run according to the new value.
- If the set time value has been modified, the operation time is not affected and will continue.

(3) Warning display

- If an error occurs during the operation, the centrifuge will brake to stop automatically, and display the error code on the time/display area. The error code can be checked in the table 10-1, and corrective actions can be applied accordingly.

8.1.5 End the operation

(1) The centrifuge will brake when it reaches the setting time or  key is pressed.

- When the rotor stops rotating, centrifuge will start beeping to alert the operation has finished.

(2) Open the door



- The door can be released automatically when the operation has stopped.
- With the door closed, you are able to press the  key to open it.
- After ending the operation, the program will store the setting parameters of this operation, and will recall these parameters when restart the program.

(3) Open the door and take out the rotor and samples.

8.2 RCF Operation

- (1) Turn on the power switch.
- (2) Set a RCF (Relative Centrifugal Force) value.

CAUTION:

- Do not exceed the allowable maximum RCF value of the rotor and adapters.
- Press the key  and choose speed unit $\times g$, the speed symbol will flash into RCF value input status.
- If no key is pressed after the speed value has flashed for 5 seconds, the input mode will be shut down.
- Rotate the key  to input a RCF value, RCF increment is $100\times g$.



- (3) Set operating conditions

The other operation, please refer to the section 8.1.

8.3 Pulse Operation

This function is used to remove the residual samples adhered on the interior of the tubes.

Note: The key works only when the rotor stopped and the door is locked.

- (1) Turn on the power switch and load the rotor to the shaft, tighten the rotor lid and make sure it is in secured position, and then close the door.
- (2) The centrifuge gets into preparation mode and displays last running values. The values can be reset.
- (3) Press  key and hold, the centrifuge will speed up to the setting speed. While releasing  key during acceleration, the centrifuge will start to decelerate and stop.

9. Maintenance

9.1 Cleaning

CAUTION

- If do not follow the recommended instructions for cleaning or disinfecting may damage the centrifuge.

- (1) Centrifuge

- If the centrifuge is exposed to ultraviolet rays for a long time, the color of the doors may be changed or the label may be came off. After using, cover the centrifuge with a piece of cloth to protect it from direct exposure.

- If the centrifuge needs cleaning, clean it with a cloth or sponge moistened with a neutral detergent solution.
 - Sterilize the centrifuge by wiping with a cloth moistened with 70% ethanol solution.
- (2) Rotor chamber

 **CAUTION**

- Do not directly pour water, neutral detergent or disinfectant solution into the rotor chamber. Otherwise fluids may leak into the drive units and cause corrosion or deterioration to the bearings.

- If the rotor chamber needs cleaning, clean with cloth or sponge moistened with a neutral detergent solution. Sterilize the centrifuge by wiping with a cloth moistened with 70% ethanol solution.

(3) Drive shaft

- We recommend regular maintenance for drive shaft. You can wipe the drive shaft with soft cloth, and then apply a thin coat of silicon grease.

(4) Door

- Clean and sterilize the door using the same method as the step (1) above.

(5) Rotor

- To prevent corrosion, remove the rotor from rotor chamber. If not in use for a lone term, then detach the rotor lid and turn upside down to dry the tube holes and keep clean.
- For sample leaks in the rotor, rinse the rotor with water. Apply a thin coat of silicon grease to the rotor when it is completely dry.
- The rotor should be regular maintenance, recommend to cleaning it each 3 months to ensure tube and rotor holes keep clean, and then apply a thin coat of silicon grease.

(6) Drain (D1536R)

- The centrifuge is equipped with drain pipe for excess water. Drain off water when water is in drain pipe.

9.2 Consumables

Replaceable wearing parts listed below. It is recommended to replace these according this table.

| Item. | Replacement parts | Replacement conditions |
|-------|---|------------------------|
| 1 | Rubber block of temperature sensor | Cracked |
| 2 | Seal ring of centrifuge chamber (3024R) | Cracked |

9.3 The replacement of rotor seal rings

9.3.1 Instructions

There are three high-temperature rubber seal rings that equipped into rotor to achieve bio-safe. The seal

rings may fall off or aging after several autoclaving, need to be replaced or re-installed.

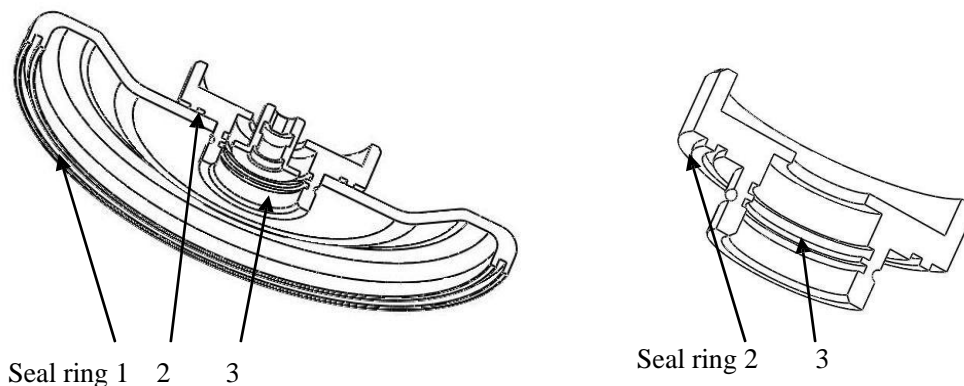

Figure 9-1 Seal rings of rotor

9.3.2 Replacement methods

- (1) Clean the seal ring slot with neutral detergent solution and make it dry.
- (2) Evenly coated with glue (501) in the seal ring slot and keep the seal ring into slot, press evenly to make it contact enough with the slot bottom and bond firmly.
- (3) Place for 20 minutes and waiting for the glue to completely solidified.

9.4 Routine inspection

- (1) Check that if the centrifuge is on a firm, flat and level table, ensure the four feet stand on the table firmly.
- (2) Check if the centrifuge grounded properly: Use multi-meter to check if is short circuit between the power cord grounding pin and the motor shaft. If yes, indicating grounded properly; if is open circuit, need to check failure reason first and make troubleshooting before use.

10. Troubleshooting

10.1 Possible problems and solutions

This centrifuge has a self-diagnostic function. If a problem occurs, an error/warning code will be displayed on the time display screen and the operator can determine the malfunction with the warning code below.

| Symptom | Causes | Solutions |
|--|--|--|
| Nothing appears on the screen when the POWER is turned on. | <ul style="list-style-type: none"> -Building power circuit breaker trips. -the fuse was blown out. | <ul style="list-style-type: none"> -Remove the trouble and turn on the POWER. -Replace the fuse. |



| | | | |
|--|-----------------------------|--|--|
| Error code appeared on the time display screen | E-02 Door fault | -The door opened in running. -Press the key  while the door opening. | -Close the door immediately. -Close the door , and then start to operate. |
| | E-03 ROTOR ID | •The centrifuge can not identify the rotor ID. | • Reconfirm the ID code of the rotor and make a correct selection. |
| | E-04 Temp sensor fault | -the connection fault. -the sensor fault. | -reconnect -Replace temperature sensor |
| | E-06 Set wrong parameter | -The setting parameter exceed the allowable range. | -Modify the parameter value. |
| | E-08 Chamber over hot | -The air inlets are blocked. -cooling fan is damaged. | -Clean air inlets. -Replace the cooling fan. |
| | E-09 imbalance | • the allowable imbalance is exceeded. • some wrong in the drive system | • Balance the sample • checked by professional person. |
| | E-10~86 | -Read the service manual. | -Contact with service center. |

Table 10-1 Possible problems and solutions

10.2 How to open the door

10.2.1 In the case of power on

 CAUTION

- The door just can be opened while the power on and rotor stops rotating.

- (1) Turn on the POWER switch, the door lock will release automatically.
- (2) The door lock will release automatically once the operation finished.
- (3) It is available to release the door by pressing key  once the rotor stops.

10.2.2 In the case of power outage

The door cannot be opened automatically if there is a power outage. It is available to be opened manually.

- (1) Ensure if the rotor has stopped rotating.
- Listen carefully to ensure no rotating sound can be heard.
- (2) Insert a screw driver into the hole to open the door.

- Two holes are located on the both sides in the top right corner of the cover.
- Insert a screw driver into the hole and push forward to release the door.

10.3 Replacement of fuses

- (1) There are two fuses, 250V, 6.3A time-delay type, size: $\Phi 5 \times 20$.
- (2) The fuse holder is located in the power inlet. Pull out the fuse holder from power inlet and replace the fuses if necessary.

11. Instructions of rotor and tube

⚠ CAUTION:

- Read the instructions thoroughly, correct use rotor.
- Do not exceed the allowable maximum speed of rotor, tube and adapters etc., be care that the allowable maximum speed of some adapters are lower than the rotor's maximum speed.

11.1 The rotor instructions

11.1.1 Rotor structure

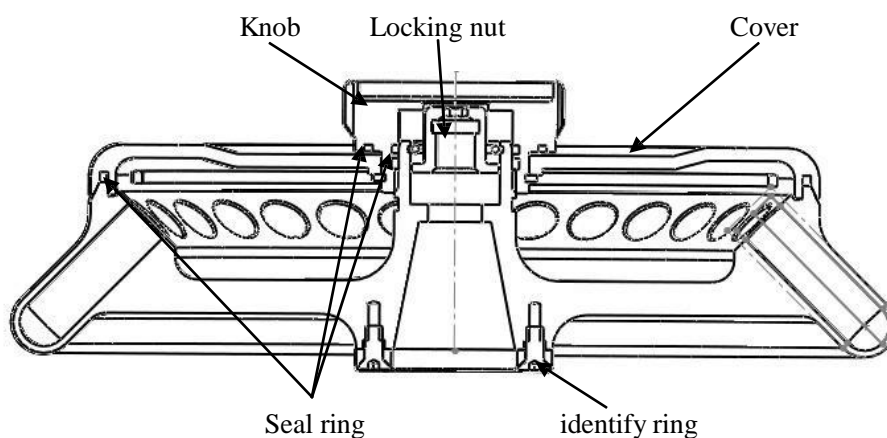

Figure 11-1 The rotor structure

11.1.2 Available rotors and adapters

Closed angle rotors, such as AS30-2, AS18-5V, AS60-2, AS12-PCR8, AS6050V, are used for bio-safe when the rotor lid was tightened with the rotor, centrifuge tubes will be enclosed into rotor to ensure the sample does not leak in centrifugal process. If rotor lid is not available, the rotor would be no bio-sealing function. The rotors can be used as follows:

| Rotor type | ID code | Tube/bottle | Adapter | Max. speed (rpm) | Max. centrifugal radius r_{max} (cm) | Max. RCF Rcf ($\times g$) |
|------------|----------------------------|---|----------|------------------|--|-----------------------------|
| 1 | AS30-2 | 2/1.5ml $\times 30$ | | 6000 | 10 | 4020 |
| | | 0.2ml $\times 30$ | A02P2 | 6000 | 8.5 | 3415 |
| | | 0.5ml $\times 30$ | A05P2 | 6000 | 9 | 3618 |
| 2 | AS60-2 | 2/1.5ml $\times 60$ | | 6000 | 10 | 4020 |
| | | 0.2ml $\times 60$ | A02P2 | 6000 | 8.5 | 3415 |
| | | 0.5ml $\times 60$ | A05P2 | 6000 | 9 | 3618 |
| 3 | AS18-5V | 5mlV $\times 18$ | | 6000 | 10 | 4020 |
| 4 | AS12-PCR8 | 8-PCR $\times 12$ | | 6000 | 10 | 4020 |
| | | 0.2ml $\times 96$ | | 6000 | 10 | 4020 |
| 5 | AS6-50V | 50mlV $\times 6$ | | 6000 | 10.7 | 4306 |
| 6 | A30-15 | 15mlV $\times 30$ | | 4500 | R1=14.2 R2=12.2 | 3210 2760 |
| 7 | A8-50 | 15mlV $\times 16$ 50mlV $\times 8$ | | 5000 | 12.4 | 3460 |
| 8 | SE4-100A | 100ml $\times 4$ | | 4000 | 15.9 | 2840 |
| | | 85ml $\times 4$ | A85P100 | 4000 | 15.9 | 2840 |
| | | 50mlV $\times 4$ | A50VP100 | 4000 | 15.9 | 2840 |
| | | 15mlV $\times 8$ | A15VP100 | 4000 | 15.1 | 2700 |
| | | 3~10ml $\times 8$ | A10P100 | 4000 | 14.7 | 2630 |
| 9 | S2-MP (dimension) mm | MTP (128 \times 85.6 \times 15) | | 4000 | 12.1 | 2160 |
| | | Cell culture (128 \times 85.6 \times 21) | | 4000 | 12.1 | 2160 |
| | | DWP (128 \times 85.6 \times 45) | | 4000 | 12.1 | 2160 |
| | | Kits (128 \times 85.6 \times 60) | | 4000 | 12.1 | 2160 |

* : 15mlV means 15ml conical tube, as well as 5mlV and 50mlV.

Table 11.1 Rotors and adapters

11.1.3 Notice

(1) The centrifuge rotor can separate sample which density lower than 2.0g/ml, if the samples density is over 2.0g/ml, please calculate allowable speed depending on the following formula.

$$\text{Allow Speed (rpm)} = \text{Maximum speed} \times (2.0(\text{g/ml}) / \text{Sample density (g/ml)})^{1/2}$$

(2) To prevent corrosion, remove the rotor from rotor chamber if do not use for a long time, then detach the rotor lid and upside the rotor down to dry the tube holes.

- (3) If some samples leaked in the rotor hole, wash the hole with water, apply a thin coat of silicon grease on the rotor surface after drying.
- (4) It is necessary for a regular maintenance for rotor, recommend to clean it each 3 months to keep cleaning of tube hole and shaft hole, and then apply a thin coat of silicon grease on it.

11.1.4 Autoclaving

- All rotors are manufactured in high-strength aluminum alloy material or stainless still and can be autoclaved: 121°C (1.0kg/cm²), 20 minutes.
- But some adapters are made of plastics, these adapters can be deformed after autoclaving, so you’d better use other disinfecting methods.

11.1.5 Bio-safe seal ring

The rotor is sealed by bio-safe structures, achieved using three high-temperature rubber seal rings. The seal rings may fall off or aging after several autoclaving, need to be replaced or re-installed. The replacement methods please refer to the section 9.3.

11.2 Tubes

11.2.1 Cleaning and sterilizing tubes

| Condition | | Material | PA | PC | PP |
|---------------|---------------------------|---|----|----|----|
| Cleaning | Cleaning fluids | Acidic (pH5 or lower) | X | X | X |
| | | Acidic (higher than pH5) | O | O | O |
| | | Alkaline (higher than pH9) | O | X | O |
| | | Alkaline (pH9 or lower) | O | O | O |
| | | Neutral (pH7) | O | O | O |
| | | Warm water(up to 70°C) | O | O | O |
| | Ultrasonic cleaning | Neutral detergent (pH7) | O | O | O |
| Sterilization | Autoclaving | 115°C (0.7kg/cm ²) 30minutes | O | O | O |
| | | 121°C (1.0kg/cm ²) 20 minutes | X | O | O |
| | | 126°C (1.4kg/cm ²) 15 minutes | X | X | X |
| | Boiling | 15 to 30 minutes | O | O | O |
| | Ultraviolet sterilization | 200-300nm | X | X | X |
| | Gas sterilization | Ethylene oxide | O | X | O |
| Formaldehyde | | O | O | O | |

PA: Polyallomer; PC: Polycarbonate; PP: Polypropylene

11.2.2 Cleaning PC tubes

PC materials are low in chemical resistance against alkaline solutions. Avoid using neutral detergents with pH higher than 9. Note that pH of some neutral detergents are still higher than 9 even if diluted according to the instruction in the maker's catalog. Use detergent with its pH between 7 and 9.

11.2.3 Autoclaving PA、PC and PP tubes

PA begins softening at about 120°C, PC and PP at about 130°C. Autoclave PA tubes at 115°C (0.7kg/cm²) for 30 minutes and PC and PP tubes at 121°C (0.1kg/cm²) for 20 minutes. If a certain temperature is exceeded, the tubes may be deformed.

When using a sterilizing chamber, please operate as follows:

- (1) Place tubes in vertical position, mouths upward. If tubes are placed sideways, they may deform into an oval shape due to gravity.
- (2) Remove screw nuts and inner covers to prevent from deformation or rupture.
- (3) Wait until the sterilizing chamber cools down to the room temperature before the tubes are removed.

11.2.4 Condition and life expectancy of tubes

The life expectancy of plastic tubes depends on the characteristics of samples, speed of the rotor used, and temperature applied, and so on. When the plastic tubes are used for centrifuge of ordinary aqueous samples (pH between 5 and 9), their life expectancies are defined as follows.

Be operated at the maximum speed:

High quality tubes (PA、PC、PP): 30-50 operations

Ordinary tubes(PA、PC、PP): around 10 operations (Using in low speed can extend the tube life) .

Life expectancy of tubes also depends on the pretreatment conditions such as cleaning and sterilization, lifetime can be cut down.

Notice: Do not use damaged or cracked tubes.

12. Calculate Relative Centrifuge Force(RCF)

Relative Centrifuge Force (RCF) can be determined with the following calculation formula.

$$RCF=1.118 \times r \times n^2 \times 10^{-5}$$

R—rotating radius, unit: cm; n—rotating speed, unit: rpm

13. Ordering information

| Cat. No. | Model | Descriptions |
|--------------------|-----------|---|
| 912015137777 | DM0636 | Multi-purpose Centrifuge, with SE4-100 rotor kits, US plug, 110V/50Hz/60Hz |
| 91211517777 | DM0636 | Multi-purpose Centrifuge, with SE4-100 rotor kits, Cn plug, 220V/50Hz/60Hz |
| 912215127777 | DM0636 | Multi-purpose Centrifuge, with SE4-100 rotor kits, Euro plug, 220V/50Hz/60Hz |
| 912315127777 | DM0636 | Multi-purpose Centrifuge, with SE4-100 rotor kits, UK plug, 220V/50Hz/60Hz |
| Accessories | | |
| 19400002 | AS30-2 | Rotor kits with cover, fixing clips and O'ring, 6000rpm, 2ml*30, used with D1536 & D1536R |
| 19400002 | AS18-5V | Rotor kits with cover, fixing clips and O'ring, 6000rpm, 5mlV*18, used with D1536 & D1536R |
| 19400003 | AS60-2 | Rotor kits with cover, fixing clips and O'ring, 6000rpm, 2ml*60, used with D1536 & D1536R |
| 19400002 | AS12-PCR8 | Rotor kits with cover, fixing clips and O'ring, 6000rpm, PCR8*12, used with D1536 & D1536R |
| 19400002 | AS6—50V | Rotor kits with cover, fixing clips and O'ring, 6000rpm, 50mlV*6, used with D1536 & D1536R |
| 19400002 | A30-15 | 30- Φ 17stainless tubes, 4500rpm, 30-15mlV tubes, used with D1536 & D1536R |
| 19400004 | A8-50 | 16- Φ 17stainless tubes and 8- Φ 31stainless tubes, 5000rpm, 16-15mlV tubes and 8-50mlV tubes, used with D1536 & D1536R |
| 19400004 | SE4-100A | 4- Φ 45stainless tubes and 4-45 stainless rings, 4000rpm, 4-100ml tubes, used with D1536 & D1536R |
| 19400004 | S2-MP | 2-buckets and 2-stainless carrier, 4000rpm, used with D1536 & D1536R |
| | A85P100 | 85ml rotor adapter, used with SE4-100 rotors, 4pcs/pk |
| | A50VP100 | 50mlV rotor adapter, used with SE4-100 rotors, 4pcs/pk |
| | A15VP100 | 15mlV rotor adapter, used with SE4-100 rotors, 4pcs/pk |
| | A10P100 | 3~10ml rotor adapter, used with SE4-100 rotors, 4pcs/pk |
| 19500001 | A02P2 | 0.2ml rotor adapter, used with AS30-2 & AS60-2 rotors, 30pcs/pk |
| 19500002 | A05P2 | 0.5ml rotor adapter, used with AS30-2 & AS60-2 rotors, |

| | | |
|--|--|------------------------|
| | | 30pcs/pk |
| | | 9 hole-bucket assembly |
| | | 4 hole-bucket assembly |
| | | 2 hole-bucket assembly |
| | | 1 hole-bucket assembly |
| | | |
| | | |

14. Warranty

14.1 Warranty of the centrifuge

This centrifuge is guaranteed for two years from the date of delivery provided that it has been operated and maintained properly.

14.2 Warranty of the rotor

The rotor is guaranteed for 5 years from the date of delivery upon manufacture. Please pay attention, do not use the rotor once it has been corrosion or fatigue damage. We do not guarantee this centrifuge and the rotor under the following conditions even if within the guarantee period expires:

- (1) Failures caused by incorrect installation.
- (2) Failures caused by rough or improper handling.
- (3) Failures caused by conveyance or relocation after installation.
- (4) Failures caused by unauthorized disassembly or modification.
- (5) Failures caused by using parts of the other companies, such as rotors and adapters.
- (6) Failures caused by natural disasters including fire, earthquakes and so on.
- (7) Consumables and parts have a limited guarantee period

15. After-sales Service

In order to ensure to operate centrifuge safely and efficiently, it is necessary for regular maintenance. If centrifuge has problems, do not attempt to repair it by yourself. Contact our sales or service center.



DLAB Scientific Inc.

Add: 775 Rivera St, Riverside, CA 92501, USA

Tel: +1- 747- 230-5179

Fax: +1-909-230-5275

E-mail: info@dlabsci.com

web: www.dlabsci.com